

INSTALLATION & SERVICE MANUAL

Under-The-Sink Reverse Osmosis Systems

Ultra 6 - KC5000



UNITED DISTRIBUTORS, INC.

11225 St. Johns Industrial Parkway N.

Jacksonville, FL 32246

www.UDIwater.com

800-741-4426

Thank you for choosing our Ultra 6 Reverse Osmosis drinking water systems. With proper care your water filtration system will produce high quality drinking water for many years. The following is a brief overview of the system.

Your Reverse Osmosis System:

Osmosis is the process of water passing through a semi permeable membrane in order to balance the concentration of contaminants on each side of the membrane. A semi permeable membrane is a barrier that will pass only certain particles like clean drinking water, but not other particles like arsenic and lead.

Read carefully and follow the instruction in this manual before proceeding with the actual installation. Pay particular attention to all warnings, cautions and notes. Failure to do so could result in personal injury or damage to the equipment or other property. System and installation need to comply with state and local laws and regulations. If you have any questions, please contact us at 800-741-4426 or call your local dealer.

Your system is a six stage RO which is based upon separate treatment segments within the one complete water filtration system. These stages are as follows:

Stage 1 – Sediment filter, recommended change 12 months

The first stage of your RO system is a five micron sediment filter that traps sediment and other particulate matter like dirt, silt and rust which affect the taste and appearance of your water.

Stage 2 – Carbon filter, recommended change 12 months

The second stage contains a 5 micron carbon block filter. This helps ensure that chlorine and other materials that cause bad taste and odor are greatly reduced.

Stage 3 and Stage 4 – KDF/GAC filter, recommended change 12 months

The third stage contains a KDF/GAC filter. KDF (Kinetic Degradation Fluxion) is a high purity copper-zinc formulation which removes chlorine, lead, mercury, iron and hydrogen sulfide from the water. Removing these impurities prolongs the life of to Reverse Osmosis membrane. The GAC filter (Granular Activated Carbon) has an extremely large amount of adsorption surface area. The design of GAC promotes high flow to the RO membrane while removing chlorine taste and odor as well as reduction of VOC's.

Stage 5- Membrane, recommended change 2-5 years

Stage five is the heart of the reverse osmosis system, the 50GPD (Gallons Per Day) RO membrane. This semi permeable membrane will effectively remove TDS (Total Dissolved Solids,), including sodium and a wide range of contaminants such as Chromium, Arsenic, Copper, Lead as well as Cysts, such as Giardia and Cryptosporidium. Because the process of extracting this high quality drinking water takes time, your RO water treatment system is equipped with a storage tank.

Stage 6- Carbon post filter, recommend change 12 months

The final stage is a high quality carbon filter. Drinking water enters this filter after the water storage tank and it is used as a final polishing filter.

Note: Filter & Membrane life may vary based upon local water conditions and/or use patterns.

System Maintenance

Just because you cannot taste it, does not mean that it is not there. Contaminants such as Lead, Chromium and Arsenic are undetectable to the taste. Additionally, over time if you do not replace the filter elements, other bad tastes and odors will be apparent in your drinking water.

It is important to change out your filters at the recommended intervals as indicated in this system manual. When replacing the filter elements, pay special attention to any cleaning instructions. If you have any questions, please contact us at 800-741-4426 or call your local dealer.

Operational Parameters

Installation must comply with State and local plumbing regulations. Do not use with water that is micro biologically unsafe or of unknown quality without adequate disinfection before or after the system.

System is intended to be installed using the cold water supply only.

Operating Temperatures:	Maximum 100°F (37.8°C)	Minimum 40°F (4.4°C)
Operating Pressure:	Maximum 100 psi (7.0 kg/cm ²)	Minimum 40 psi (2.80 kg/cm ²)
pH Parameters:	Maximum 11	Minimum 2
Iron:	Maximum 0.2 ppm	
TDS (Total Dissolved Solids)	< 1800 ppm	
Turbidity	< 5 NTU	
Hardness	Maximum 10 Grains Per Gallon *	

Hardness: Recommended hardness not to exceed 10 grains per gallon, or 170 parts per million.

* System will operate with hardness over 10 grains but the membrane life may be shortened.

Addition of a water softener may lengthen the membrane life.

Water Pressure: The operating water pressure in your home should be tested over a 24 hour period to attain the maximum pressure. If the incoming water pressure is above 100 psi then a water pressure regulator is required. A booster pump is needed for incoming water pressure under 40psi.

Copper Tube: Reverse Osmosis water should not be run through copper tube as the purity of the water will leach copper causing an undesired taste in water and pin holes may form in the tube.

Contents of the Reverse Osmosis (RO) System

- 1 Water Storage Tank 2.8 gallon capacity
- 1 Module
- 5 Filter Cartridges
- 1 Installation kit: tank ball valve, drain saddle valve, feed water adapter
- 1 Faucet Bag
- 1 Manual



INSTALLATION & STARTUP

Tools Recommended For Installation

- √ 1/2" Diamond Tipped Hole Saw bit for faucet opening (Counter Tops/Porcelain & Stainless Sinks)
- √ 1 1/4" Adjustable Wrench
- √ 1/2" Open End Wrench
- √ 5/8" Open End Wrench
- √ Electric Drill
- √ 1/8" diamond tip bit, pilot hole
- √ 1/4" drain saddle hole
- √ Phillips bit for electric drill
- √ Needle Nose Pliers
- √ Adjustable Pliers
- √ Sharp Knife
- √ Phillips Screw Driver



Ultra 6 - KC5000

ITEM	QTY	PART NO.	DESCRIPTION
1	1	KC5001	ULTRA 6 MANIFOLD
2	1	KC5002	SEDIMENT FILTER 5 MICRON 11"
3	1	KC5003	CARBON BLOCK 5 MICRON 11"
4	1	KC5004	KDF/GAC CARBON FILTER 11"
5	1	KC5005	TFC MEMBRANE 11"
6	1	KC5006	POST CARBON GAC FILTER 11"
7	1	70-3521	TANK SHUT OFF VALVE 3/8 X 1/4
8	1	70-6020	2.8 GALLON WHITE STEEL TANK
9	1	70-5542	703 SERIES BRUSHED NICKLE FAUCET
10	1	09-9160	ANGLE STOP ADAPTER
11	1	09-0515	DRAIN SADDLE 1 1/2 X 1/4QC
12	1	70-0143	FLOW CONTROL (Black Tube Conn.)
13	1	70-3536	FAUCET QC ADAPTER FITTING
14	1	09-0006	AUTO SHUT OFF (SEE PAGE 12)

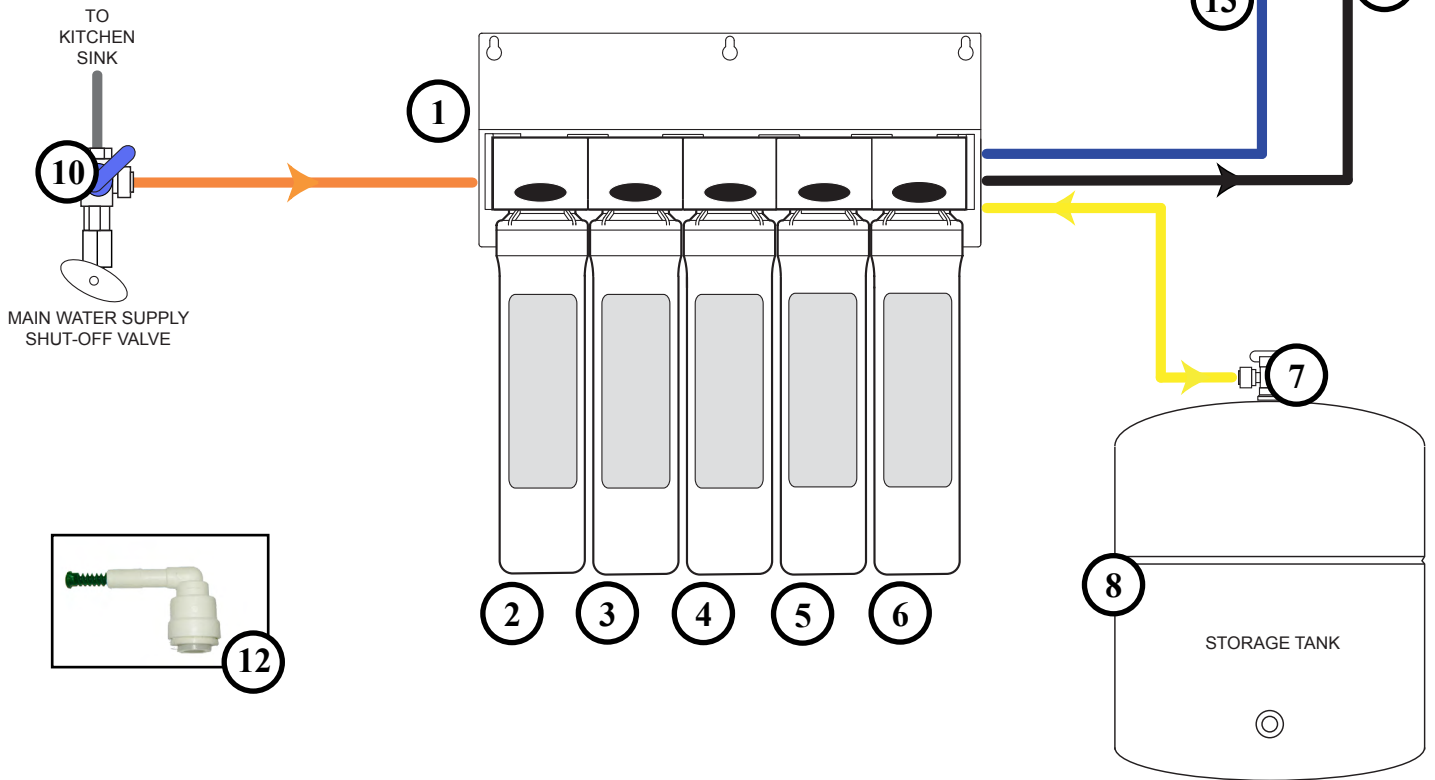

FILTER REPLACEMENT SCHEDULE:

ITEM#	DESCRIPTION	SERVICE LIFE
KC5002	Sediment filter, 5 micron, 11"	12 months
KC5003	Carbon Block filter, 5 micron, 11"	12 months
KC5004	KDF/GAC Carbon filter, 11"	12 months
KC5005	TFC membrane, 50GPD @ 60PSI / 75GPD @ 100PSI	36-60 months
KC5006	Post Carbon GAC filter, 11"	12 months

Drill a Hole for the Reverse Osmosis Faucet

Marble Counter-top

We recommend contacting a qualified contractor for drilling a hole in a marble counter-top.

Counter Top / Porcelain & Stainless Steel Sink

Note: Most sinks are pre drilled with 1 ¼” diameter hole that you can use for your RO faucet. (If you are already using it for a sprayer or soap dispenser, see step 1) Porcelain sinks are extremely hard and can crack or chip easily. Use extreme caution when drilling. UDI accepts no responsibility for damage resulting from the installation of faucet. Diamond tip bit recommended.

- 1) Determine desired location for the RO faucet on your sink and place a piece of masking tape over where the hole is to be drilled. Mark the center of the hole on the tape.
- 2) Using a variable speed drill set on the slowest speed, drill a 1/8” pilot hole through both porcelain and metal casing of sink at the marked center of the desired location. Use lubricating oil or liquid soap to keep the drill bit cool (If drill bit gets hot it may cause the porcelain to crack or chip).
- 3) Using a 1/2” diamond tip hole saw, proceed to drill the large hole. Keep drill speed on the slowest speed and use lubricating oil or liquid soap to keep the hole saw cool during cutting.
- 4) After drilling, remove all sharp edges and make sure the surroundings of the sink are cooled before mounting the faucet.



How to use the Quick Connect Fittings

To make a connection, the tube is simply pushed into the fitting. The unique locking system holds the tube firmly in place without deforming it or restricting flow. Use the steps below in reference to any quick connect tube connections.

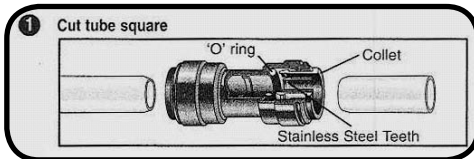

It is essential that the outside diameter be free of score marks and that burrs and sharp edges be removed before inserting into fitting.

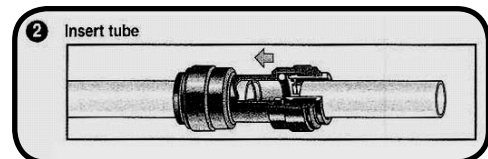

Fitting grips before it seals. Ensure tube is pushed into the tube stop.

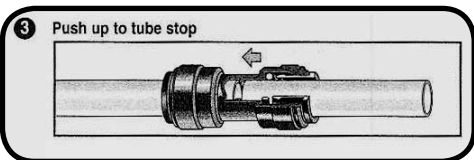

Push the tube into the fitting, to the tube stop. The collet (gripper) has stainless steel teeth which hold the tube firmly in position while the O-ring provides a permanent leak proof seal.

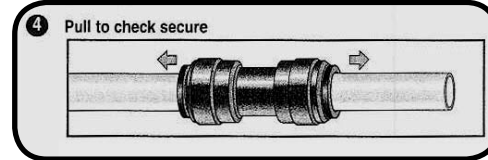

Pull on the tube to check that it is secure. It is a good practice to test the system prior to leaving site and /or before use.

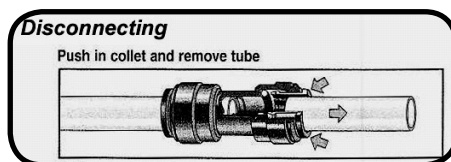

To disconnect, ensure the system is depressurized before removing the tube. Push in the collect squarely against face of fitting. With the collet held in this position, the tube can be removed. The fitting can then be reused.

Rear View of the KC5000 System - Connections



INSTALLATION

STEP 1: INSTALLING THE FAUCET

- 1) Pass the small rubber washers, the chrome base plate and the large rubber washer in that order over the threaded mounting tube at the base of the faucet.
- 2) From under the sink, install the large metal (or plastic) washer and the star washer over the threaded stem. Screw on the nut and tighten.
- 3) In the parts bag locate the plastic female threaded quick connect faucet adapter fitting. Thread it on to the faucet stem - be careful not to overtighten as it may crack the fitting.

Please see <Fig. 1> and <Fig. 2>

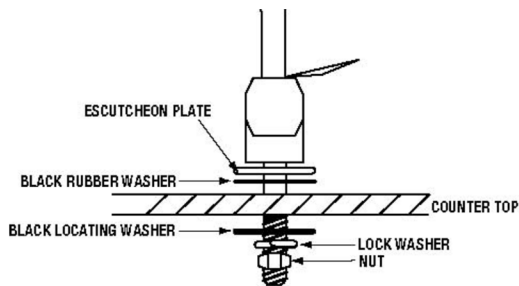

<Fig. 1>

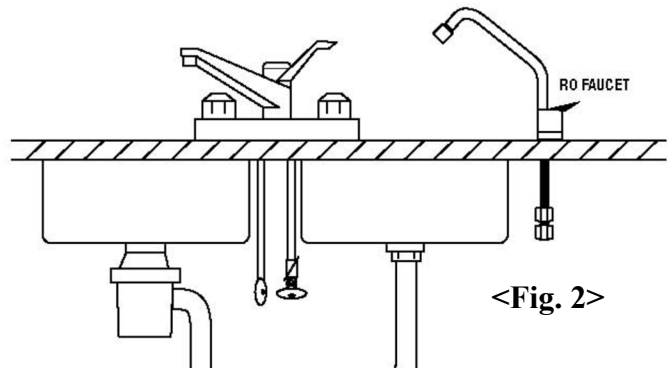

<Fig. 2>

Non Air-Gap Faucet

- 4) In the parts bag, locate the blue 1/4" tube. Connect one open end of the blue tube to the RO faucet 1/4" quick connect fitting making sure the tube is pushed in all the way to the tube stop.
- 5) Connect the other open end of the blue 1/4" tube to the elbow fitting on the back of the RO module labeled "FAUCET" making sure the tube is pushed in all the way to the tube stop.

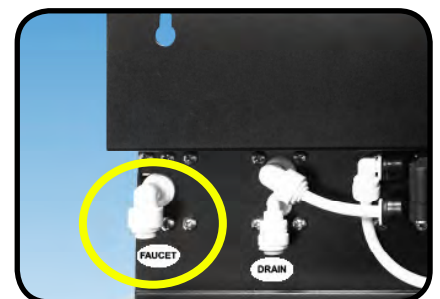

STEP 2: TAPPING INTO COLD WATER LINE

Caution: The water supply to your unit MUST be from the COLD WATER LINE. Hot water will severely damage your R.O. System.

- 1) Locate cold water angle shut off valve underneath the sink and turn it off. Open cold water faucet to release the pressure. On single handled faucets, the hot water may have to be turned off to prevent any hot water cross over. If water continues to come out of faucet with angle valves turned off, the house main will have to be turned off.
- 2) Locate the angle stop adapter in the installation kit.
- 3) Disconnect the cold water supply line from the angle stop water valve and install the Angle Stop Adapter as pictured.

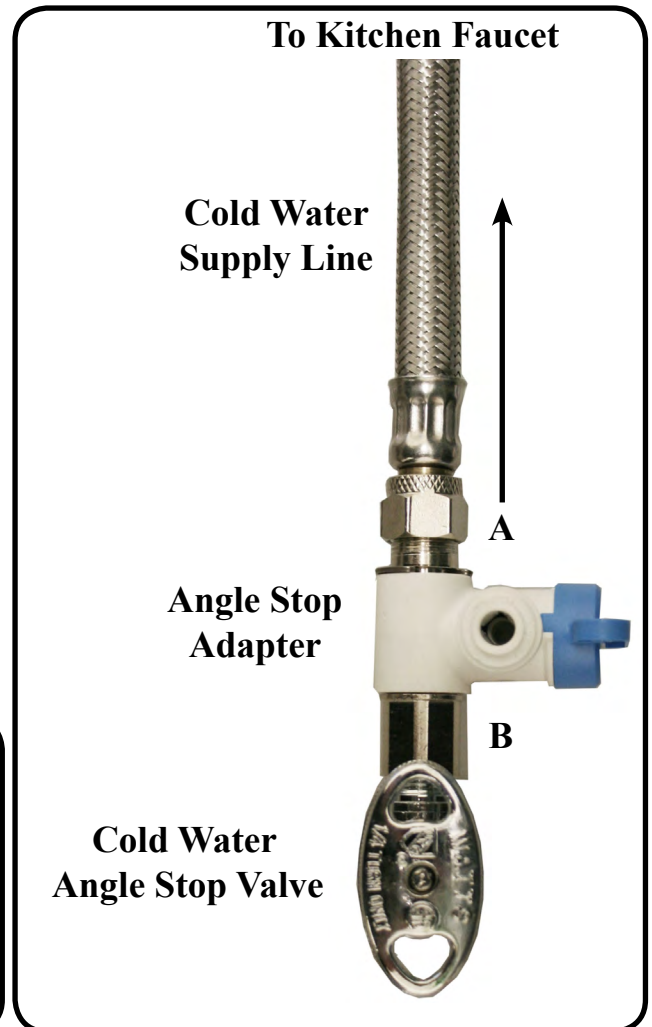
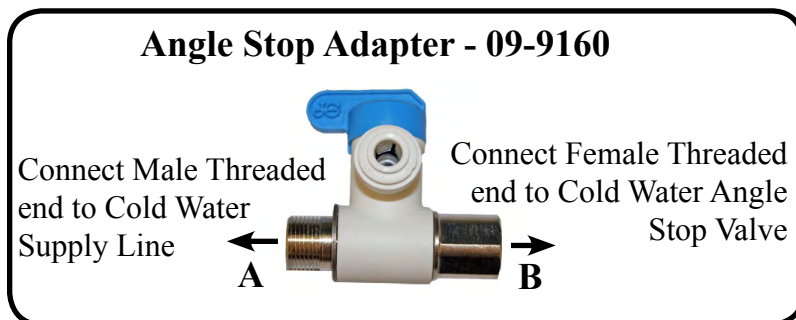

- 4) In the parts bag, locate the 1/4" orange tube. Connect the tube to the elbow fitting on the back of the RO Module labeled "IN" making sure the tube is pushed in all the way to the tube stop.

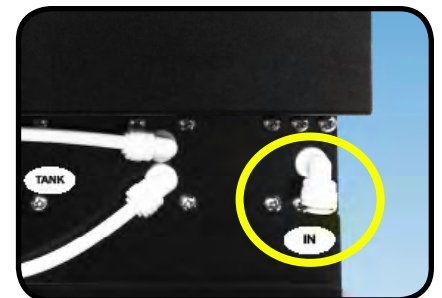

- 5) Insert the open end of the orange 1/4" tube into the open 1/4" quick connect fitting on the plastic angle stop adapter valve making sure the tube is pushed in all the way, past the O-ring to the tube stop.

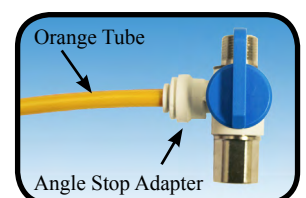

Drain Saddle Installation - Fits standard 1 ¼” – 1 ½” drain pipes (09-0215)

Caution: *If you have a garbage disposal, do not install the drain saddle near it. Installation of the drain saddle must be either above the garbage disposal, or if a second sink drain is available, install it above the cross bar on the second drain. Installation of the drain saddle near a garbage disposal may cause the drain line to plug.*

Follow all local plumbing codes for your installation.

- 1) Locate the drain saddle kit in the parts bag.
- 2) The small square black foam gasket with a circle cut out of the middle must be applied to the inside of the drain saddle. Remove sticky tape backing and stick to the drain saddle. (See Picture to Right)
- 3) The drain saddle must be installed at least 1 ½” above the nut of the P-Trap elbow or cross bar from the garbage disposal to insure proper drainage. Using the 1/4” drill bit, drill into the drain pipe at best available location as specified above, for drain saddle installation. **Take extreme caution to only drill through one side of the drain pipe.**
- 4) Assemble the drain saddle around the drain pipe and **align drain saddle fitting opening with the hole drilled in the previous step** - you may use a small screwdriver to feed through the drain saddle into the drain pipe to aid with the alignment. Using a Phillips screw driver tighten the drain saddle bolts evenly and securely on both sides.

Caution: *Do not over tighten the screws. It may crack the drain saddle.*

- 5) In the parts bag, locate the 1/4” black tube. Connect the tube to the elbow fitting on the back of the RO Module labeled “DRAIN” making sure the tube is pushed in all the way to the tube stop.

- 6) Push the 1/4” black drain tube open end through the quick connect fitting in the drain saddle, making sure the tube is pushed all the way to the tube stop.

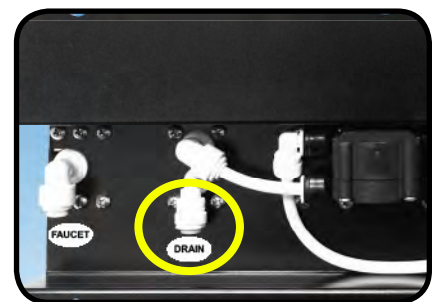
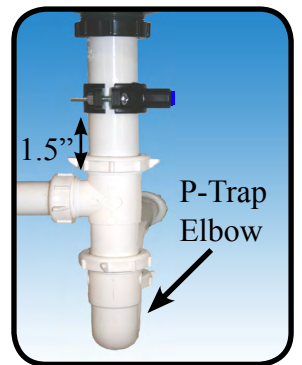
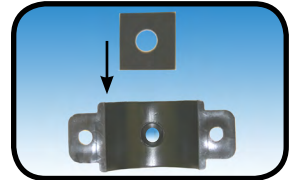
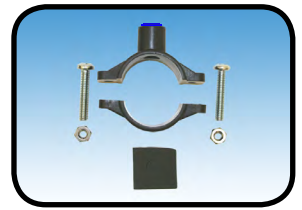

STEP 3: MOUNTING THE TANK BALL VALVE

Note: Do not tamper with the air valve on low side of storage tank. It has been preset at 8-10 psi by the manufacturers.

- 1) Unplug the plastic cap on the top of the tank.
- 2) Wrap the thread 3 times with plumbers (Teflon) tape only.
- 3) Thread the ball valve on to the tank threaded connection. Make sure it is snug but not over tighten.
See <Fig. 5>.
- 4) In the parts bag, locate the 1/4" yellow tube. Connect the yellow tubing to the tank ball valve, making sure the tube is pushed in all the way to the tube stop.
- 5) Turn the tank ball valve off.

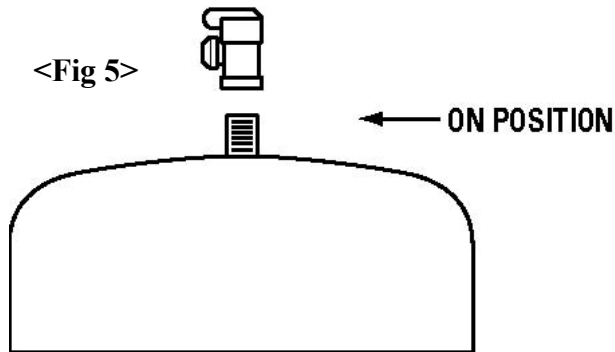

**TOPVIEW OF TANK BALL VALVE
(PART# 70-3521)**

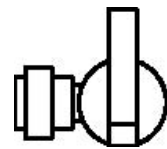

OFF POSITION

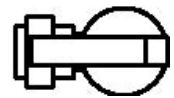

ON POSITION

- 6) Connect the open end of the 1/4" yellow tube to the elbow fitting on the back of the RO Module labeled "TANK" making sure the tube is pushed in all the way to the tube stop.



REVERSE OSMOSIS MODULE MOUNTING

Determine best location for the RO module to be mounted to allow for future system maintenance. Using the mounting holes on the bracket, mark the location for the mounting screws on the cabinet wall under the sink. In the parts bag, locate the two self tapping screws. Using an electric drill with a Phillips bit, screw them into the cabinet at the marked location. Hang the module on the screws using the mounting holes in the bracket.



INSTALL THE CARTRIDGES

Identify each cartridge and the proper location on the system by matching the label on the individual filter heads and filter cartridges.

Insert each cartridge into the corresponding head with a 1/4" turn in the clock-wise direction. The cartridge is installed properly when the label is facing toward the front of the unit.



STEP 5: SYSTEM START UP

- 1) Turn on the cold water supply and the under sink angle stop adapter but close the tank ball valve (#09-9160).
- 2) Open RO faucet (#70-5542) (lower handle) for continuous flow.
- 3) Check system for leaks, tighten as necessary.
- 4) After 10-30 minutes, the water will start to drip out of the RO faucet. Let it drip for about 10 minutes and then flip the handle to the closed position. **TURN ON THE TANK BALL VALVE NOW**. It will now take several hours (2-3) for the storage tank to fill, depending on the local water pressure.

CAUTION: DO NOT DRINK THE WATER FROM THE FIRST TWO TANKS PRODUCED BY YOUR NEWLY PURCHASED SYSTEM!

NOTE:

- 5) After the tank is full (you will hear the water stop), flush the system by placing the RO faucet handle in the open position until the water is completely discharged.
- 6) Upon complete discharge of storage tank, turn handle to closed position on RO faucet and let the refilling process begin. This process could take 2-3 hours to complete.
- 7) After the second tank is filled, repeat #6. Then enjoy your filtered water.
- 8) Check leaks daily for first week and periodically thereafter.
- 9) You may notice that the water may be milky colored during the first week. It is the air bubbles in the water. It is normal and safe.

NOTE:

- 1) Do not use with water that is microbiologically unsafe or of unknown quality without adequate disinfection before or after the system. Systems certified for cyst reduction may be used on disinfected water that may contain filterable cysts.
- 2) This reverse osmosis system contains a replaceable component critical to the efficiency of the system. Replacement of the reverse osmosis component should be with one of identical specifications, as defined by the manufacturer, to assure the same efficiency and contaminant reduction performance.

WARNING: Do not use this RO system appliance to purify non-drinkable sources of water that are unsafe or with water of unknown quality.

WARNING: Never use hot water or freeze unit.

WARNING: Incorrect installation will VOID the warranty.

CLEANING PROCEDURES

Note: *Sanitization procedure must be performed before a filter change.*

- 1) Turn off the water supply to your RO system at the angle stop adapter and open the RO faucet to drain the storage tank.
- 2) Disconnect the yellow tube from the ball valve on the storage tank.
- 3) Using a clean eye dropper insert 1 tablespoon of hydrogen peroxide or common household bleach into the yellow tube. This will flow into the tank once water is turned back on to unit. Reattach yellow tube to the ball valve. Follow startup procedure and drain two full tanks of water. **Then, replace carbon Post-filter.**



CHECK AIR PRESSURE IN STORAGE TANK

Important: *Check air pressure only when tank is empty of water!*

Check air pressure in the storage tank when you notice a decrease in available water from the RO system. Air can be added with a bicycle pump using the schrader valve that is located on the lower side of the tank behind the blue plastic cap.

- 1) Turn off the incoming water supply to the RO.
- 2) Open the RO Faucet and allow water to drain from the tank until it is completely empty.



Tip: *When water from the RO faucet slows to a trickle, with the faucet still in the open position, you may add air to the tank to purge any left over water, this will ensure that the tank is completely empty.*

- 3) Once all water in the tank is purged, check air pressure using an air pressure gauge, it should read between 8-10 PSI. (Digital air pressure gauge is recommended)
 - 4) Follow startup procedure.
- **A maintenance record should be kept for the RO system, including information about the replacement parts, when service was performed, and by whom.**
 - ***It is recommended that you completely drain the RO Tank every month.***

PREVENTIVE MAINTENANCE

These recommendations are intended to maximize efficiency of RO water production by your system.

1) Filter maintenance

- a) It is OK to store filters on the shelf for several years.
- b) To store the sealed, unopened filter, we recommend that it be kept in an air tight container. This prolongs the shelf life of the carbon filter (particularly filter was ordered more than one year before its intended use) and avoid having the filter absorb any possible odor from the air

2) Membrane maintenance

- a) The dry packed membrane usually has a two-year shelf life. To prolong the shelf life, we recommend keeping unopened dry membrane in a refrigerator.
- b) Once the membrane is in use, we recommend running the RO system every day for at least 10-15 minutes (about 1 gallon or 4 liters of drinking water). This helps to maintain the membrane performance.
- c) If the RO system is not used for over a week, drain the storage tank first. Then fill the tank and drain it twice. Your RO system is now ready to use again.

*Your RO module is equipped with valved heads which will automatically turn off the water supply to each filter when the filter is released, thus you do not need to turn off the incoming water supply at the angle stop adapter. **The RO faucet must be off when filters are replaced.** To make the removal of the filter cartridges easier, the heads & cartridges may be swiveled up to 90 degrees.*

Annual Maintenance -(Sanitization Recommended, See Page 10)

Replace:	√ One sediment pre-filter	(P/N: KC5002 11")
	√ One carbon pre-filter	(P/N: KC5003 11")
	√ One KDF/GAC carbon pre-filter	(P/N: KC5004 11")
	√ One carbon post-filter	(P/N: KC5006 11")

Step 1 Place a towel under the RO module to catch any excess water that may drip out from the filters during the changeover.

Step 2 **To remove a filter cartridge:** Grasp the cartridge and pull it towards you. Rotate the cartridge 1/4 turn counter clockwise to remove.

Step 3 **To install a filter cartridge:** Remove the seal cap and insert the cartridge into the valved head with the label facing to the left (9 o'clock position) rotating it clockwise 1/4 turn.

Note: *Flush two tank fulls after completing the annual maintenance.*

Membrane Replacement (2 - 5 Years)

Replace: √ One 50GPD Membrane (P/N: KC5005 11")

Membranes have a life expectancy between 2 and 5 years, depending on the incoming water conditions and the amount the RO system is used. This reverse osmosis membrane is critical for effective reduction of total dissolved solids (TDS). The product water should be tested periodically to verify that the system is performing satisfactorily.

Normally, a membrane would be replaced during a semiannual or annual filter change. However, if at any time you notice a reduction in water production or an unpleasant taste in the reverse osmosis water, it could be time to replace the membrane. United Distributors Inc. recommends replacing the membrane when TDS reduction falls below 75%.

Flow Control

Your reverse osmosis system is equipped with a Spiral flow control. This flow control is pre-installed inside of the drain connection elbow, it is maintenance free and does not need to be replaced when the RO membrane is changed.

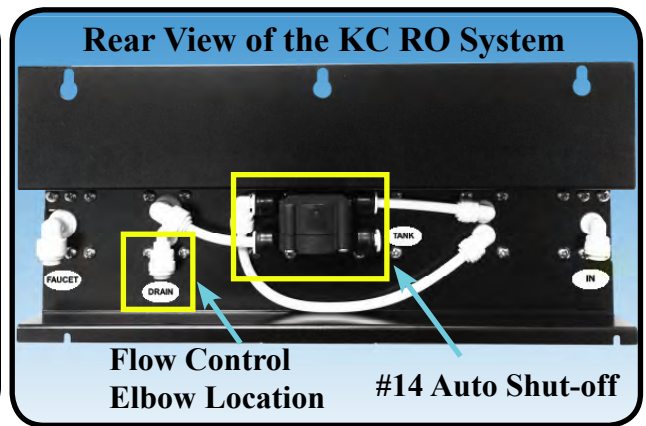
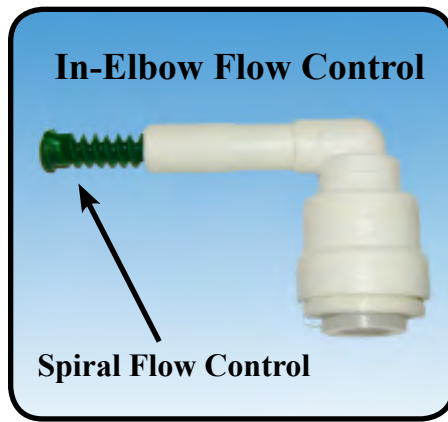

Procedure for Extended Non-Use (More than 2 months)

Turn off the water supply to your RO system at the adapt-a-valve and open the RO faucet to drain the storage tank. Once the storage tank is empty, remove all filter cartridges (order not important), place them into a sealed plastic bag and store in your refrigerator.

To Restart System:

- Step 1 Reinstall all filters on to the RO unit. Filters are labeled to match the filter heads they twist in to. Refer to page 8 for cartridge installation procedure.
- Step 2 Turn on water supply to the system at the angle stop adapter. (Check frequently over the next 24 hours to ensure no leaks are present).
- Note:** *If you have connected your RO system to a refrigerator / ice maker, make sure the ice maker is off (do not allow water to flow to the ice maker) until the tank has been allowed to completely fill.*
- Step 3 Open the RO faucet and leave it open until water begins to trickle out (it will come out slowly).
- Step 4 Close the RO faucet allowing the storage tank to fill with water. It may take 2 to 3 hours to fill the tank completely depending on the production capability of the membrane, local water temperature and water pressure.
- Step 5 After the Tank has filled, open the RO Faucet to flush the tank completely. You will know that the tank is empty when the flow rate from the RO faucet is down to a trickle. The second tank can be used for drinking.

TROUBLE SHOOTING

Note: turn off the system before servicing

PROBLEM	CAUSE	SOLUTIONS
Milky colored water	Air in system	Air in the system is a normal occurrence with initial startup of the RO system. This milky look will disappear during normal use within 1 to 2 weeks.
Small amount of water from storage tank	System just starting up Air pressure in storage tank is low	Normally it takes 2-3 hours to fill tank. Low water pressure and/or temperatures can reduce production rate. Add pressure to storage tank. The pressure should be 8-10 psi when the tank is empty
Slow production	Low water pressure Crimps in tubing Clogged pre-filters Fouled membrane	Add a booster pump Make sure tubing is straight Replace pre-filters Replace membrane
Water taste or smell offensive	Post carbon is depleted Fouled membrane Sanitizer not flushed out	Replace post carbon Replace membrane Drain storage tank and Refill it overnight
No drain water	Clogged flow control	Replace flow control
Leaks	Fittings are not tightened Twisted O-ring Misalignment of hole in drain saddle	Tighten fittings as necessary Replace a o-ring Realign drain saddle

UNITED DISTRIBUTORS, INC.
11225 St. Johns Industrial Parkway North
Jacksonville, FL 32246

Ultra 6 - KC5000

GENERAL USE CONDITIONS:

1. System to be used with municipal or well water sources treated and tested on regular basis to insure bacteriological safe quality. DO NOT use with water that is microbiologically unsafe or unknown quality without adequate disinfection before and after the system. Systems certified for cyst reduction may be used on disinfected water that may contain filterable cysts.
2. Operating Temperature: Maximum: 100°F (40.5°C) Minimum: 40° (4.4°)
3. Operating Water Pressure: Maximum: 100 psi (6.0kg/cm2) Minimum: 40 psi (2.8kg/cm2)
4. pH 2 to 11
5. Maximum Iron present in incoming water supply must be less than 0.2 ppm.
6. Hardness of more than 10 grains per gallon (170 ppm) may reduce RO membrane life expectancy.
7. Recommend TDS (Total Dissolved Solids) not to exceed 1800 ppm.

RECOMMENDED REPLACEMENT PARTS AND CHANGE INTERVALS:

Note: Depending on incoming feed water conditions replacement time frame may vary.

<u>Description</u>		<u>Change time Frame</u>
Sediment Pre-filter:	#KC5002	12 Months
Carbon Pre-filter:	#KC5003	12 Months
KDF/GAC Pre-filter:	#KC5004	12 Months
50 GPD R.O. Membrane:	#KC5005	36 to 60 Months
Carbon Pst-filter:	#KC5006	12 Months

This system has been tested according to NSF/ANSI 58 for reduction of the substances listed below. The concentration of the indicated substances in water entering the system was reduced to a concentration less than or equal to the permissible limit for water leaving the system as specified in NSF/ANSI 58. This system has been tested for the treatment of water containing pentavalent arsenic (also known as As (V), As (+5), or arsenate) at concentrations of 0.30 mg/L or less. This system reduces pentavalent arsenic, but may not remove other forms of arsenic. This system is to be used on water supplies containing a detectable free chlorine residual at the system inlet or on water supplies that have been demonstrated to contain only pentavalent arsenic. Treatment with chloramine (combined chlorine) is not sufficient to ensure complete conversion of trivalent arsenic to pentavalent arsenic.

	Avg. In. (mg/L)	Avg. Eff. (mg/L)	% Reduction	pH	Pressure	Max Eff. mg/L	Inf. challenge concentration mg/L	Max Allowable concentration mg/L
Arsenic (Pentavalent)	.310	0.001	99.6%	7.24	50psi	0.002	0.30±10%	0.010 mg/L
Barium Reduction	9.2	0.08	99.0%	7.64	50psi	0.12	10.0±10%	2.0
Cadmium Reduction	0.031	0.0004	98.0%	7.49	50psi	0.0008	0.03±10%	0005
Chromium (Hexavalent)	0.30	0.002	99.0%	7.24	50psi	0.004	0.03±10%	0.1
Chromium (Trivalent)	0.30	0.001	99.0%	7.64	50psi	0.002	0.03±10%	0.1
Copper Reduction	3.2	0.02	99.0%	7.40	50psi	0.04	3.0±10%	1.3
Cysts	92,000#/ml	3 #/ml	99.99%	7.44	50psi	18	minimum 50,000/mL	N/A
Fluoride Reduction	8.7	0.19	97.0%	7.24	50psi	0.3	8.0±10%	1.5
Lead Reduction	0.15	0.002	98.8%	7.39	50psi	0.005	0.15±10%	0.0107
Radium 226/228	25pCi/L	5pCi/L	80.0%	7.24	50psi	5pCi/L	25pCiL±10%	5pCiL
Selenium	94.85	<0.2	97.0%	7.24	50psi	<0.2	0.10±10%	0.05
TDS	741	22	97.0%	7.28	50psi	26.0	750±40mg/L	187
Turbidity	11.3	0.1	99.0%	7.43	50psi	0-1	11±1mg/L	0.5NTU

Recovery - 15.77%

Daily Production Rate - 18.43 GPD

Efficiency - 8.82%

Depending on water chemistry, water temperature, and water pressure, R.O. System production and performance will vary. Efficiency rating means the percentage of the influent water to the system that is available to the user as reverse osmosis treated water under operating conditions that approximate typical daily usage. Recovery rating means the percentage of the influent water to the membrane portion of the system that is available to the user as reverse osmosis treated water when the system is operated without a storage tank or when the storage tank is bypassed. REFER TO OWNER'S INSTALLATION/SERVICE MANUAL FOR FURTHER MAINTENANCE REQUIREMENTS AND WARRANTY INFORMATION.

LIMITED LIFETIME GUARANTEE

Residential R.O.

United Distributors hereby guarantees to the original purchaser (only) that as long as he/she owns the following equipment it will be free of defects in material and workmanship from date of original installation. The exceptions to this guarantee are as follows:

- *1. Storage Tank - 60 Months
- *2. Faucet Assembly - 60 Months
- *3. Flow Control, O-rings, Tubing, Fittings and Shut Off Assembly - 36 Months
- *4. TFC Membrane - 36 Months, Prorated 4th-36th Months
- *5. Disposable Cartridges - No Guarantee

*Guarantee only for manufacturing defects

GENERAL CONDITIONS

Damage to any part of the Reverse Osmosis unit because of misuse, misapplication, neglect, alteration, accident, physical damage, fouling and/or scaling of membrane by dirt, sediment, minerals or bacterial attack, installation or operation, contrary to our printed instructions, or damage caused by freezing, flood, fire, or an Act of God are not covered by this guarantee. In all such cases, parts and service charges will apply. Parts returned to UDI should be sent with freight to and from factory, MRA plus handling charges, paid by customer.

We assume no guarantee liability in connection with this Reverse Osmosis unit other than as specified herein. (THIS GUARANTEE IS IN LIEU OF ALL OTHER GUARANTEES, EXPRESS OR IMPLIED, INCLUDING GUARANTEE OR FITNESS FOR A PARTICULAR PURPOSE.) We do not authorize any person or representative to assume for us any other obligations on the sale of this Reverse Osmosis unit.

This guarantee becomes affective when the guarantee registration form is returned to UNITED DISTRIBUTORS, INC. within ten (10) days after the installation. Information on the form must be completed by you or your UDI dealer.

Behind this product are years of research, design and production skills. Your Reverse Osmosis unit has been carefully tested and approved at our factory. Through this guarantee, we are demonstration our confidence in UDI equipment.

FOR THIS GUARANTEE TO BE VALID, THE FOLLOWING CONDITIONS MUST BE MET:

Membrane	TFC
Water Pressure	40 - 100 PSI
Water Temperature	40° F - 100° F
pH	2-11
TDS-Max	1800PPM